

350-ECE 断面図

- ① ECEカバープレート (t=2.0)
- ② ECEブラケット (P=400)
- ③ 止水補助シートホルダー
- ④ ウェザーストリップ
- ⑤ 止水補助シート (別発注)
- ⑥ ドリルねじ (トラス頭4×13)
- ⑦ 木ねじ (5.5×40)
- ⑧ アンカーフ ラク (φ8)

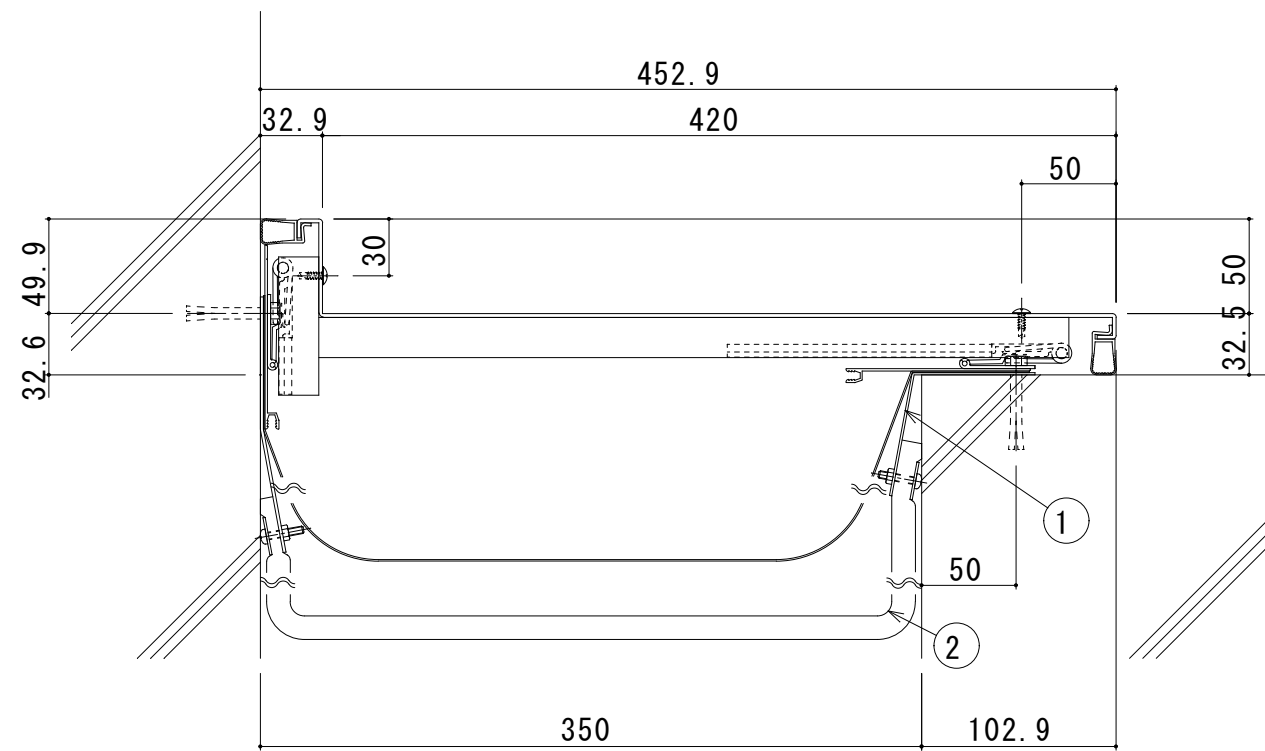

350-ECE (遮炎仕様) 断面図

- ① 耐火帯押えプレート
- ② 耐火帯

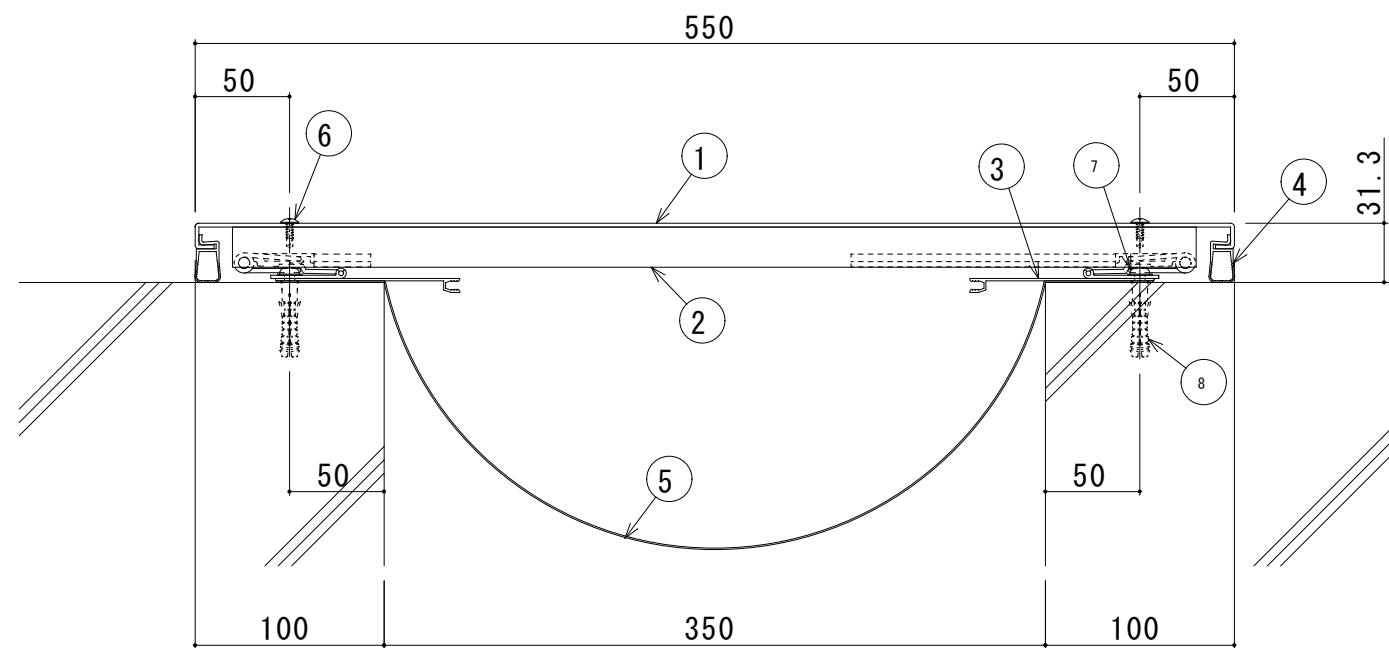

350-EE 断面図

- ① EEカバープレート (t=2.0)
- ② EEブラケット (P=400)
- ③ 止水補助シートホルダー
- ④ ウェザーストリップL
- ⑤ 止水補助シート (別発注)
- ⑥ ドリルねじ (トラス頭4×13)
- ⑦ 木ねじ (5.5×40)
- ⑧ アンカーフック (φ8)

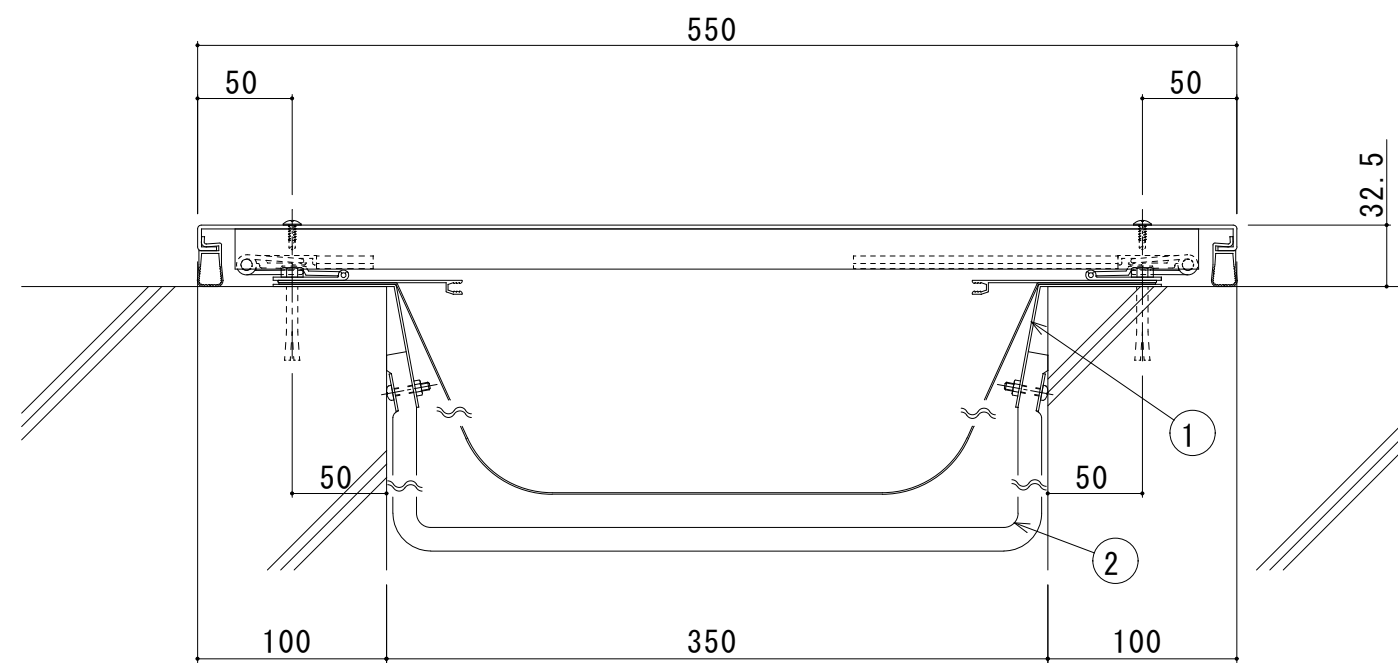

350-EE (遮炎仕様) 断面図

- ① 耐火帯押えプレート
- ② 耐火帯

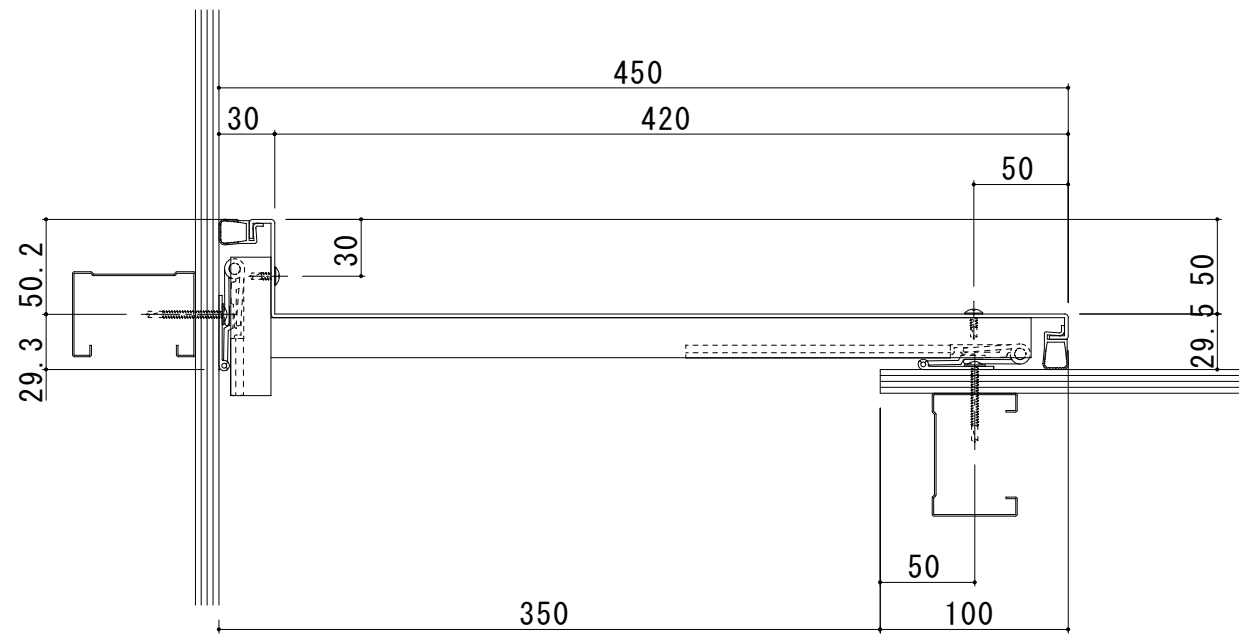

350-ICE 断面图

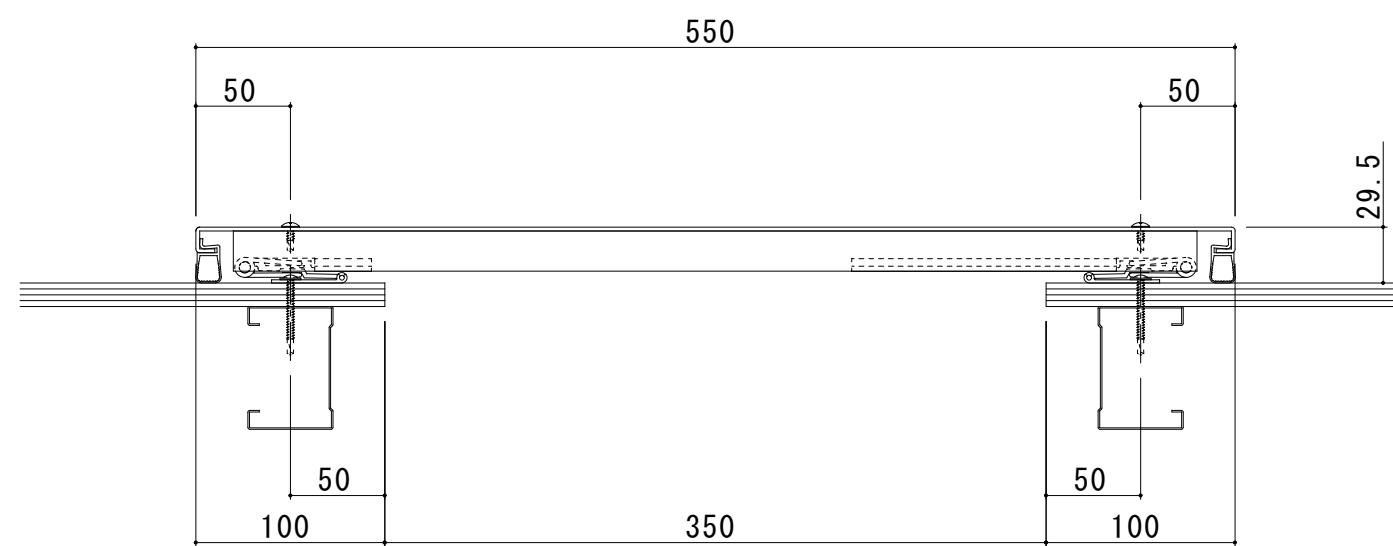

350-IE 断面图

【350mm用 耐火帯】

350-BE



350-BCE



350-BN



350-BCN

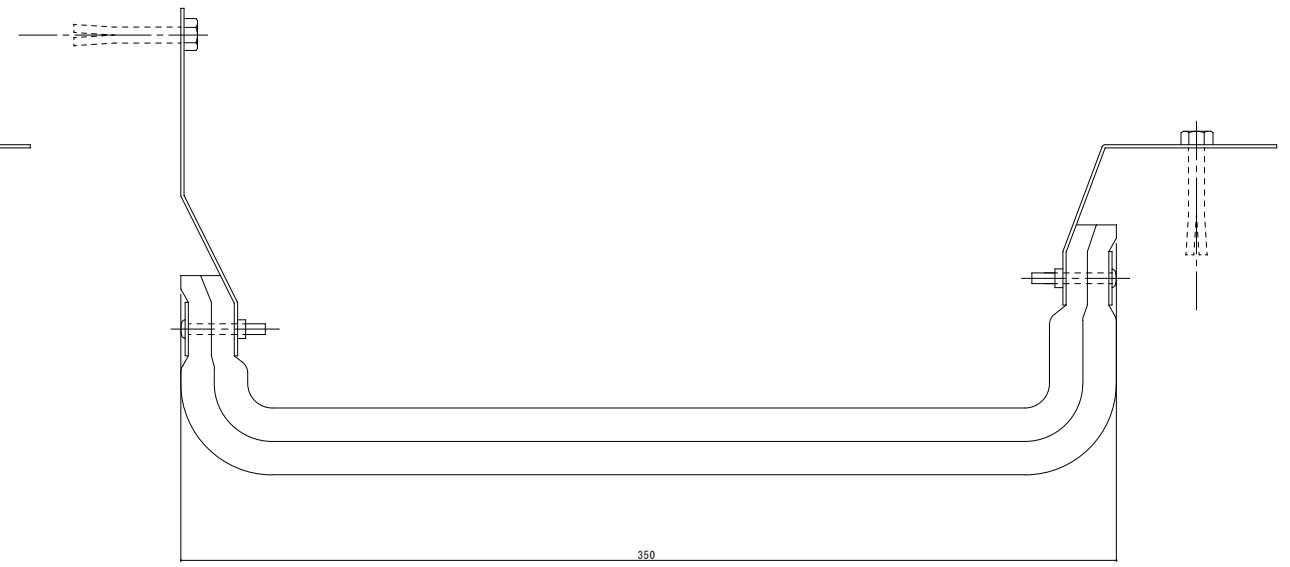

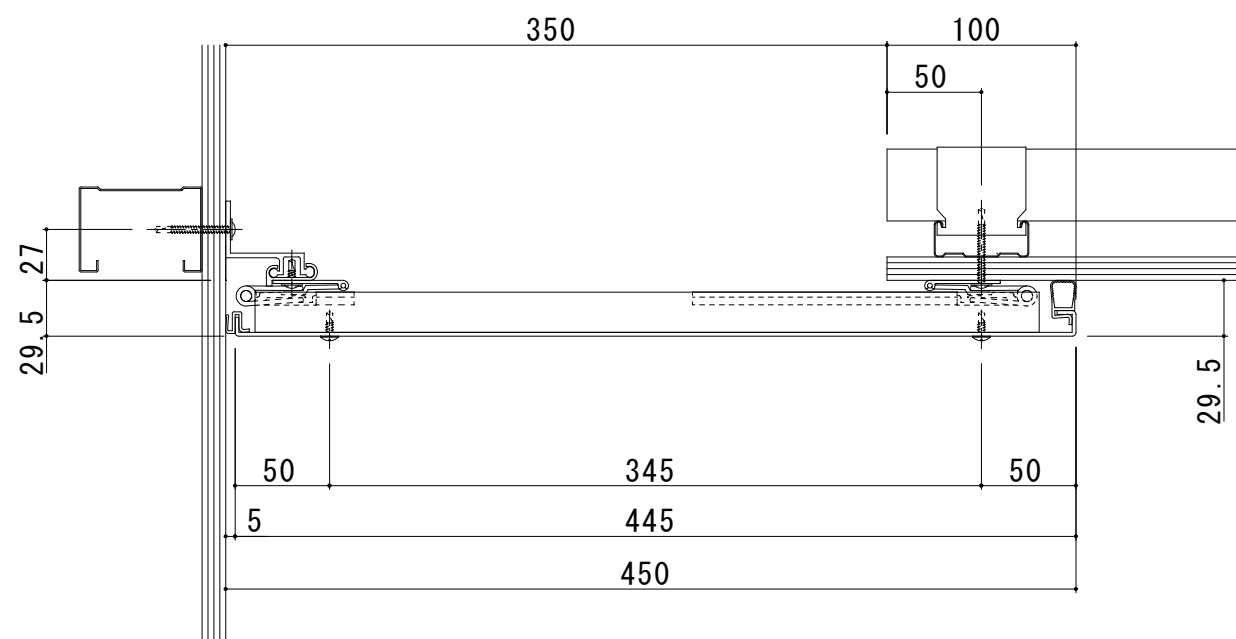

350-TCE 断面图



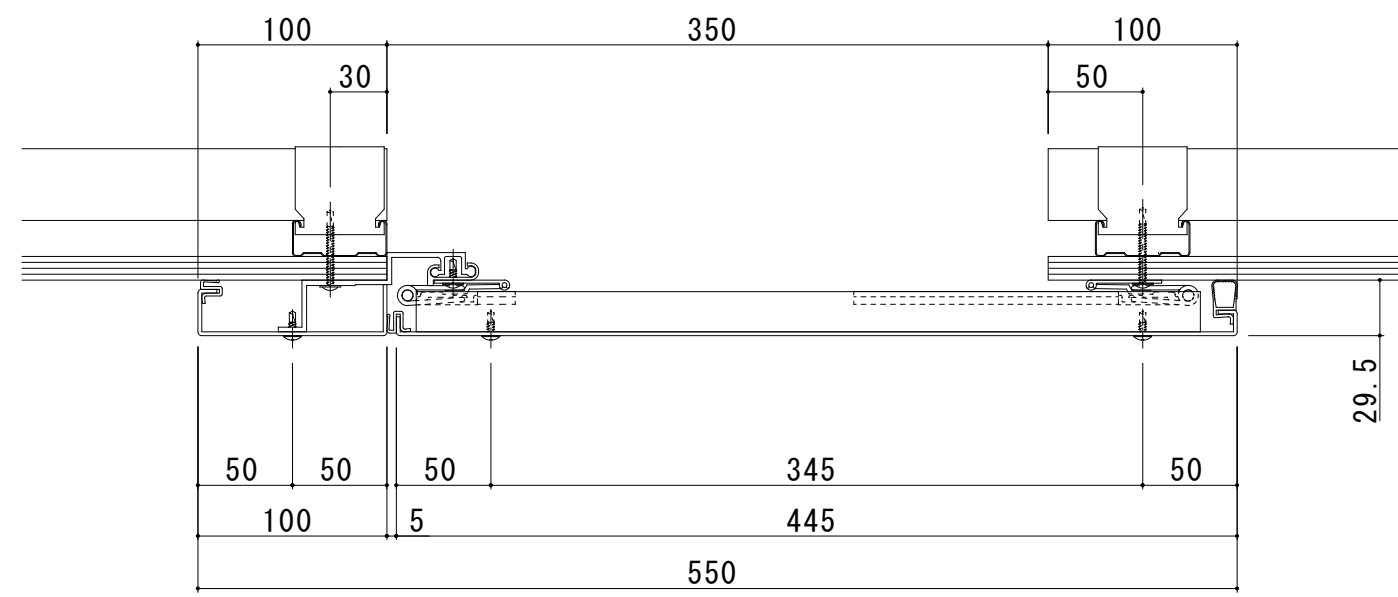

350-TE 断面图

# 屋根 - 外壁 (アルミ)

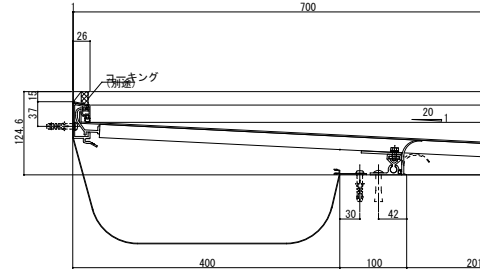
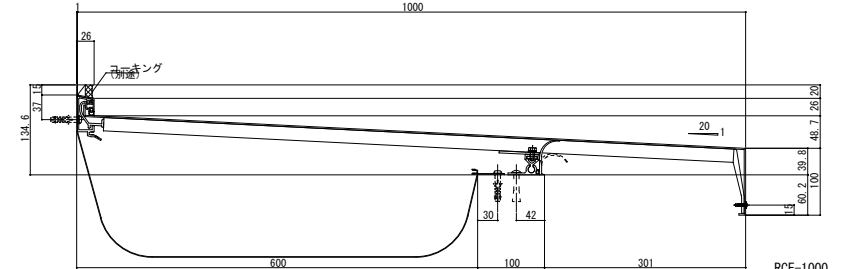
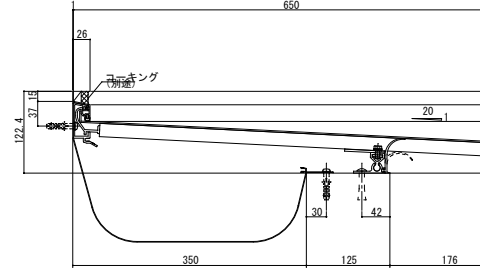
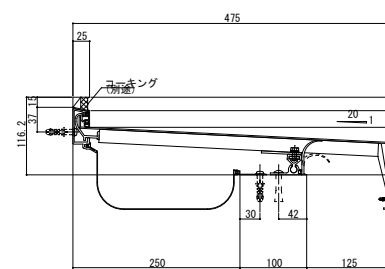
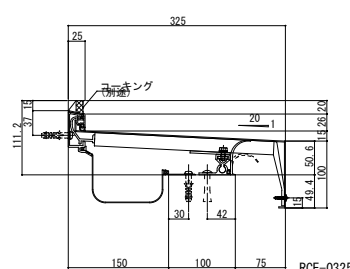
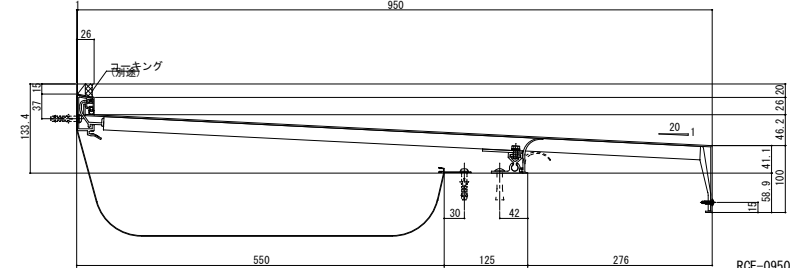
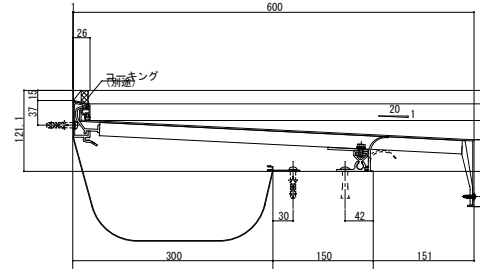
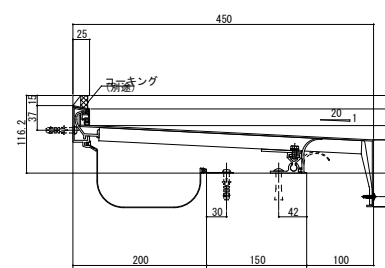
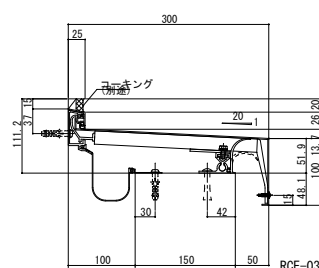
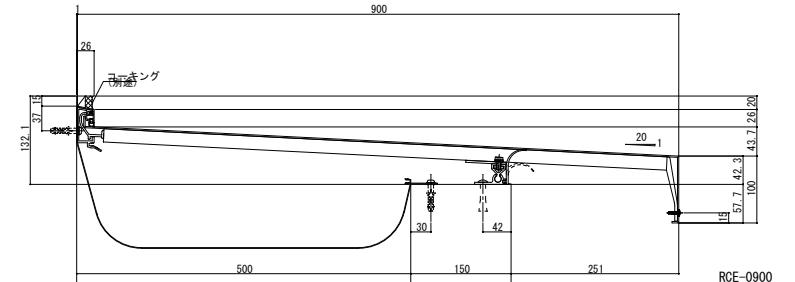
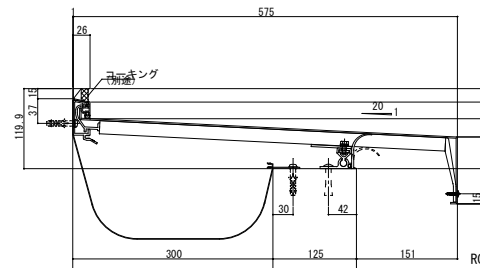
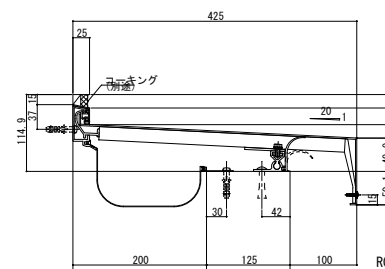
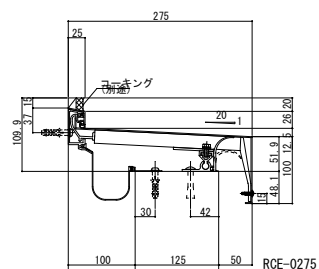
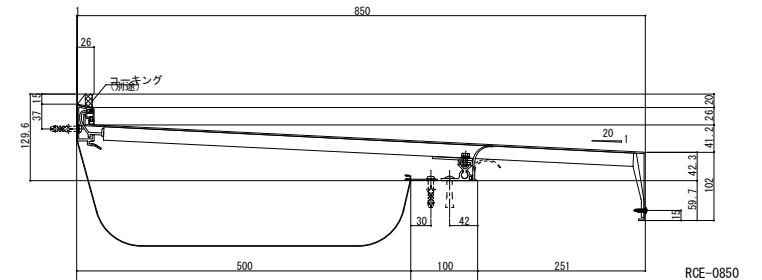
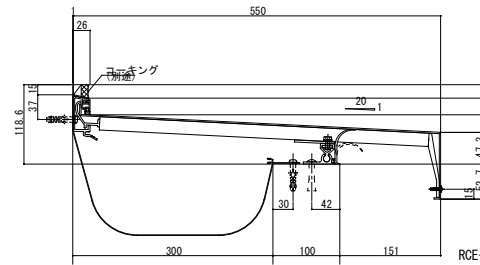
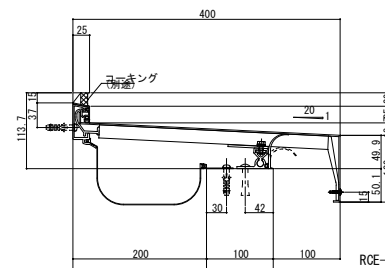
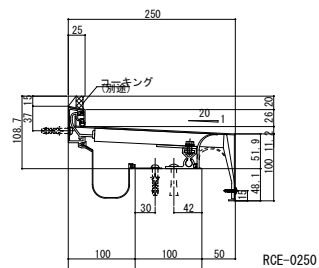
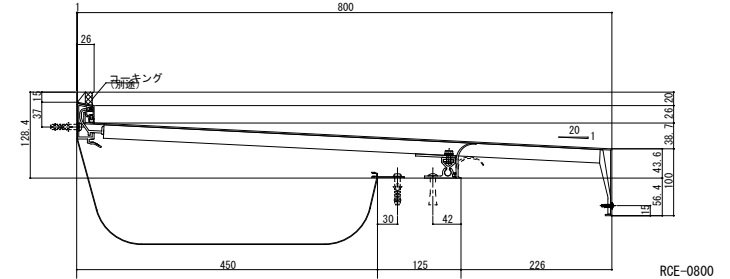
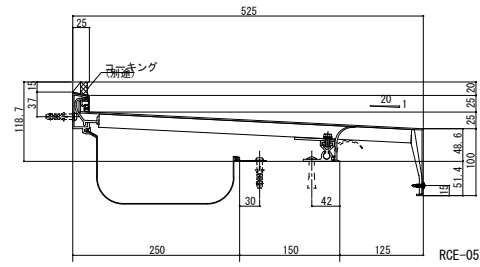
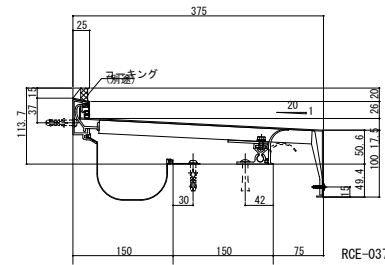
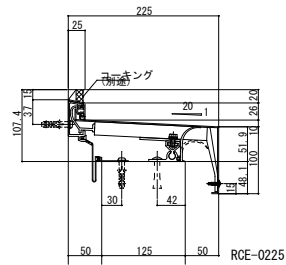
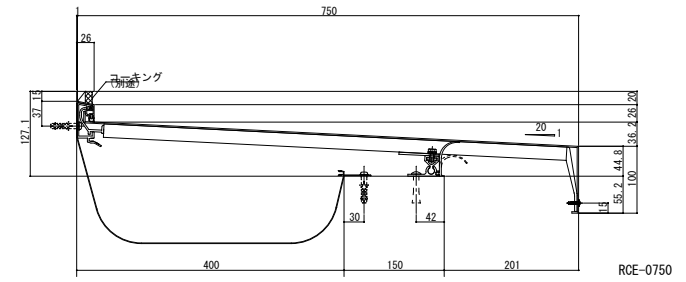
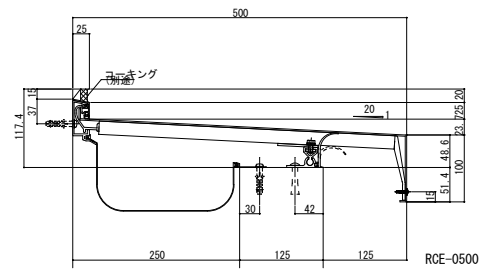
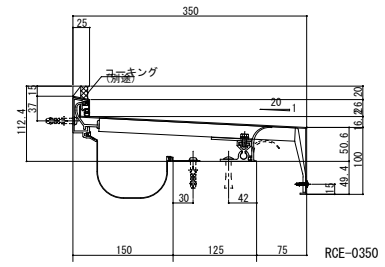
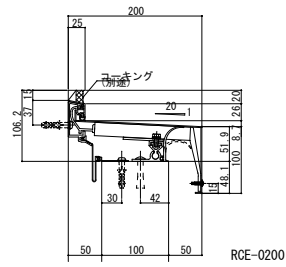
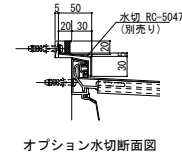
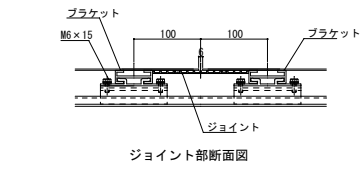

# 屋根－屋根（アルミ）

