

400-ECE 断面図

- ① ECEカバープレート (t=2.0)
- ② ECEブラケット (P=400)
- ③ 止水補助シートホルダー
- ④ ウェザーストリップ
- ⑤ 止水補助シート (別発注)
- ⑥ ドリルねじ (トラス頭4×13)
- ⑦ 木ねじ (5.5×40)
- ⑧ アンカーブ`ラク` (φ8)

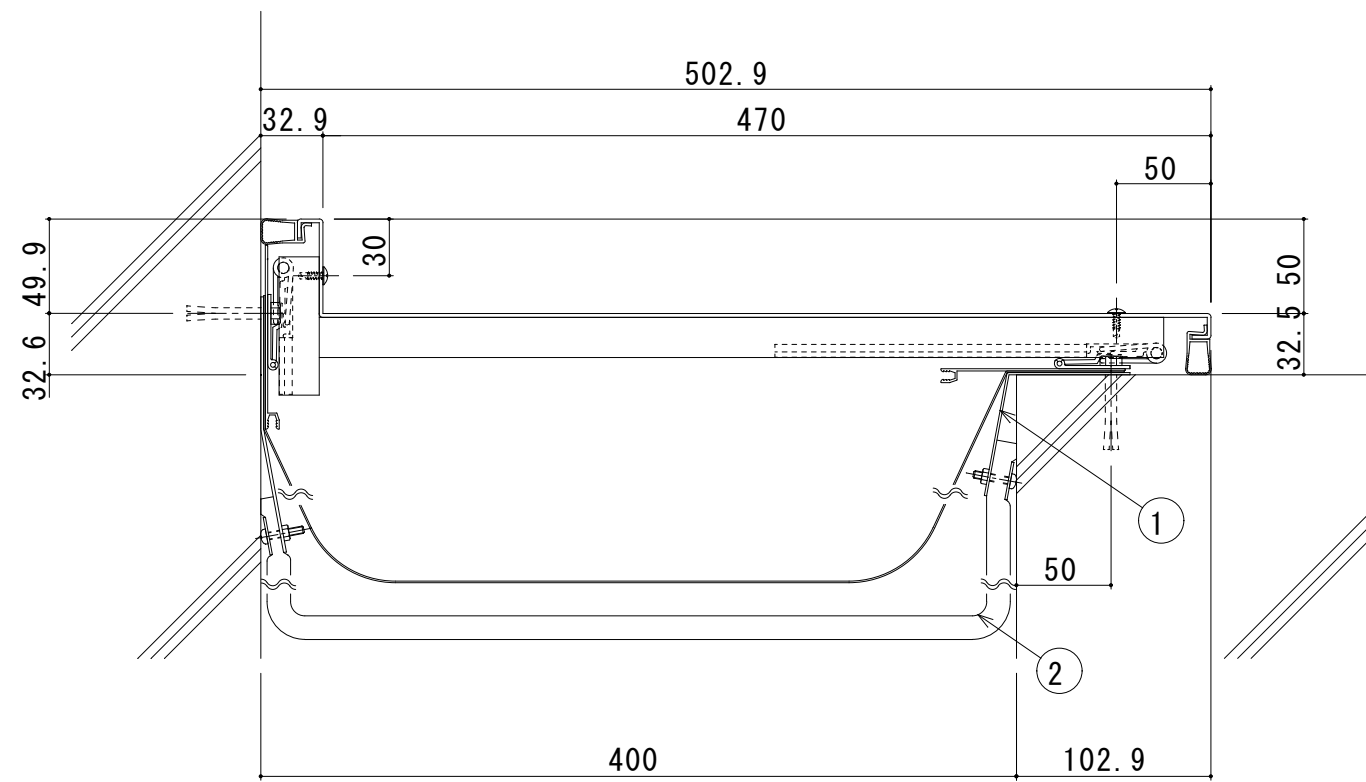

400-ECE (遮炎仕様) 断面図

- ① 耐火帯押えプレート
- ② 耐火帯

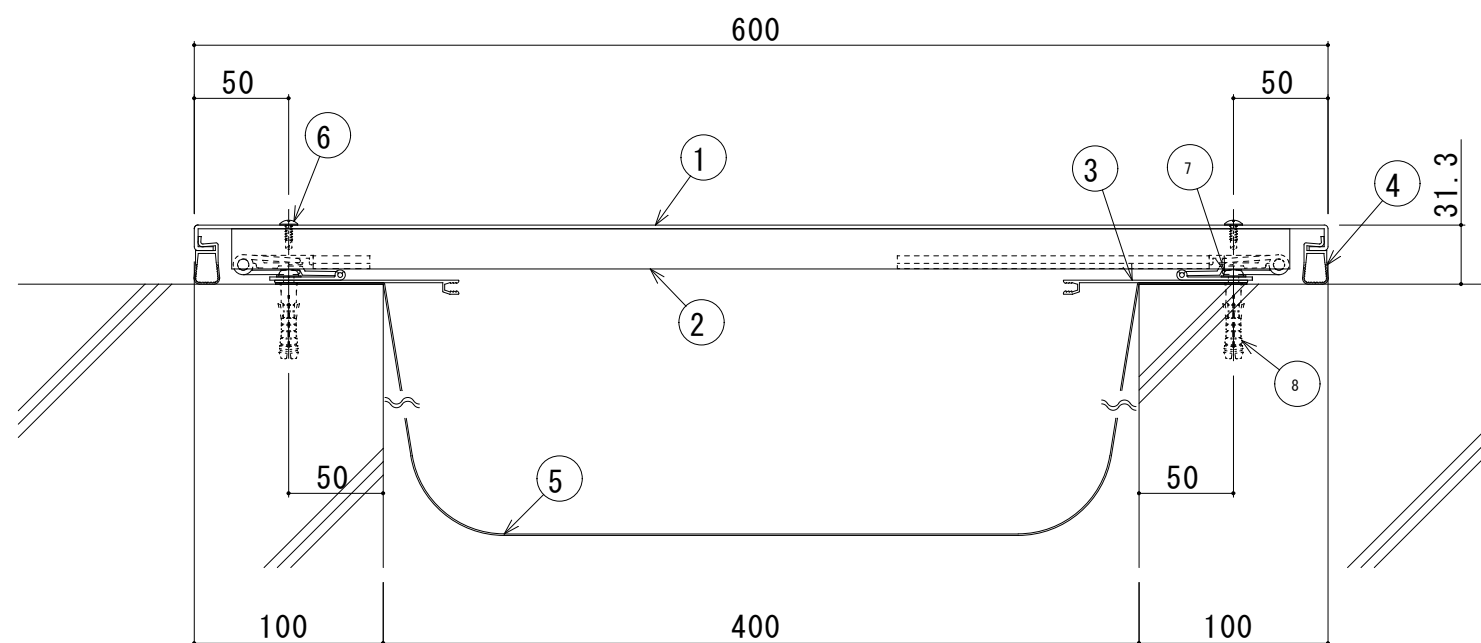

400-EE 断面図

- ① EEカバープレート (t=2.0)
- ② EEブラケット (P=400)
- ③ 止水補助シートホルダー
- ④ ウェザーストリップ
- ⑤ 止水補助シート (別発注)
- ⑥ ドリルねじ (トラス頭4×13)
- ⑦ 木ねじ (5.5×40)
- ⑧ アンカー'ラク' (φ8)

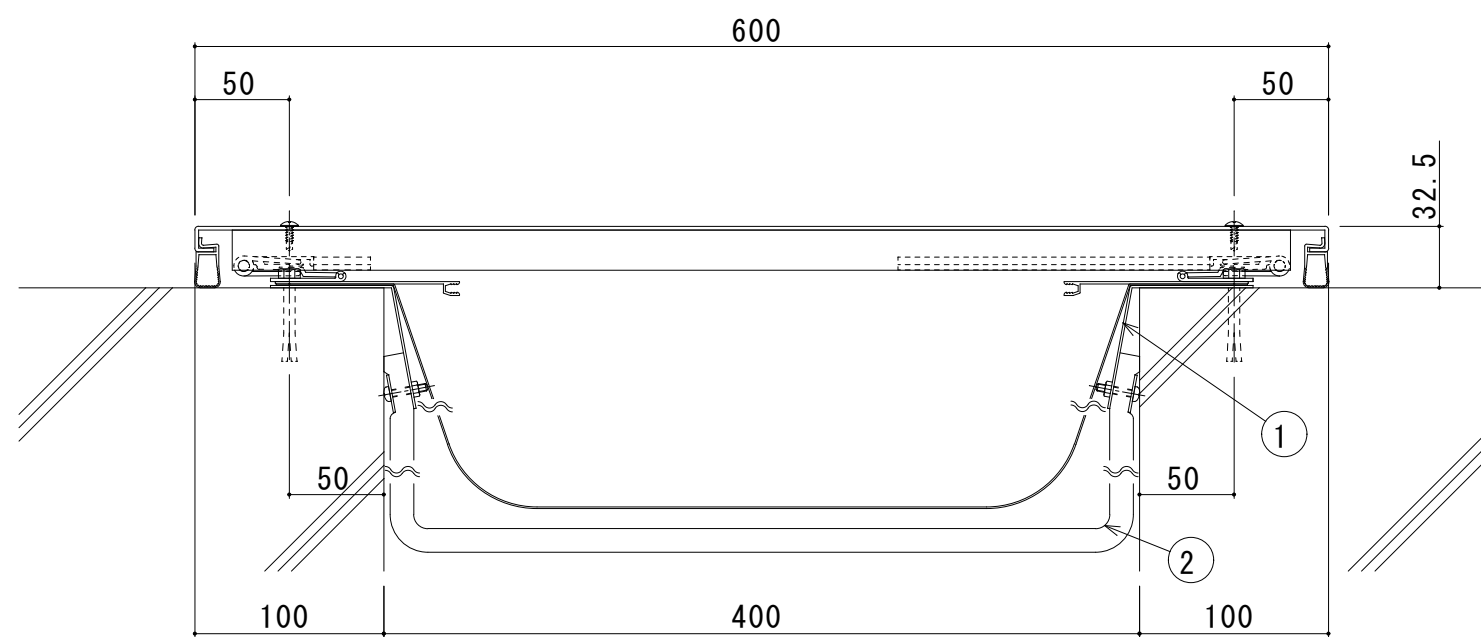

400-EE (遮炎仕様) 断面図

- ① 耐火帯押えプレート
- ② 耐火帯

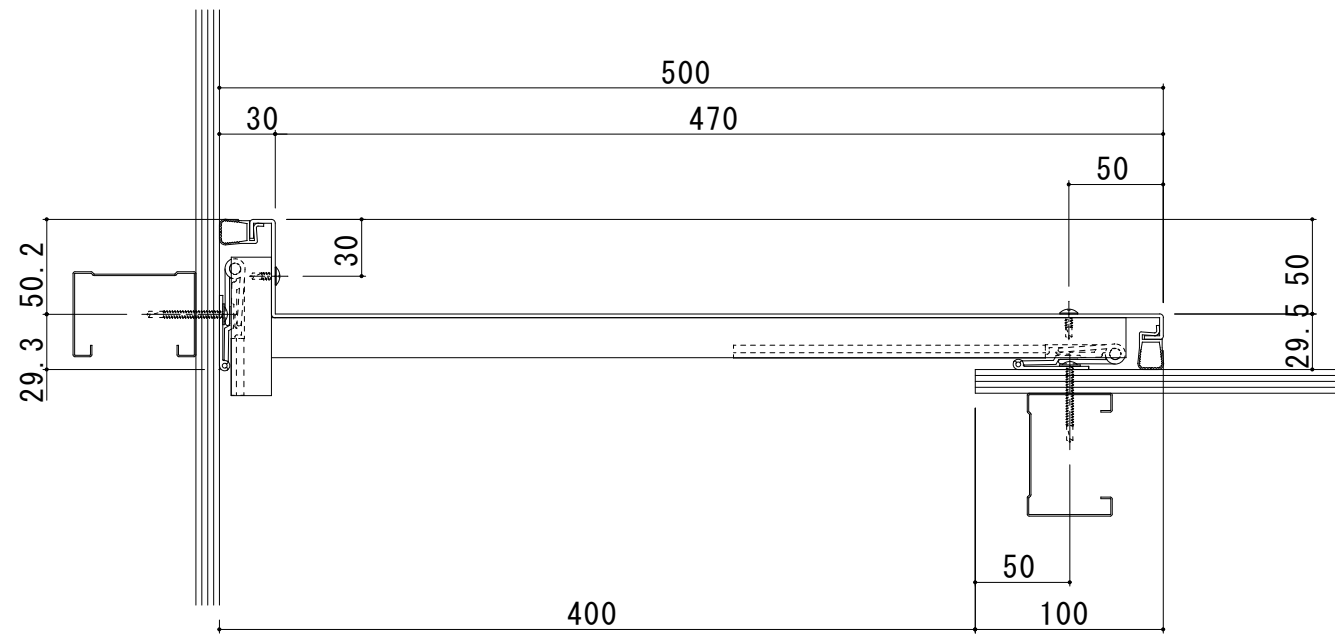

400-ICE 断面图

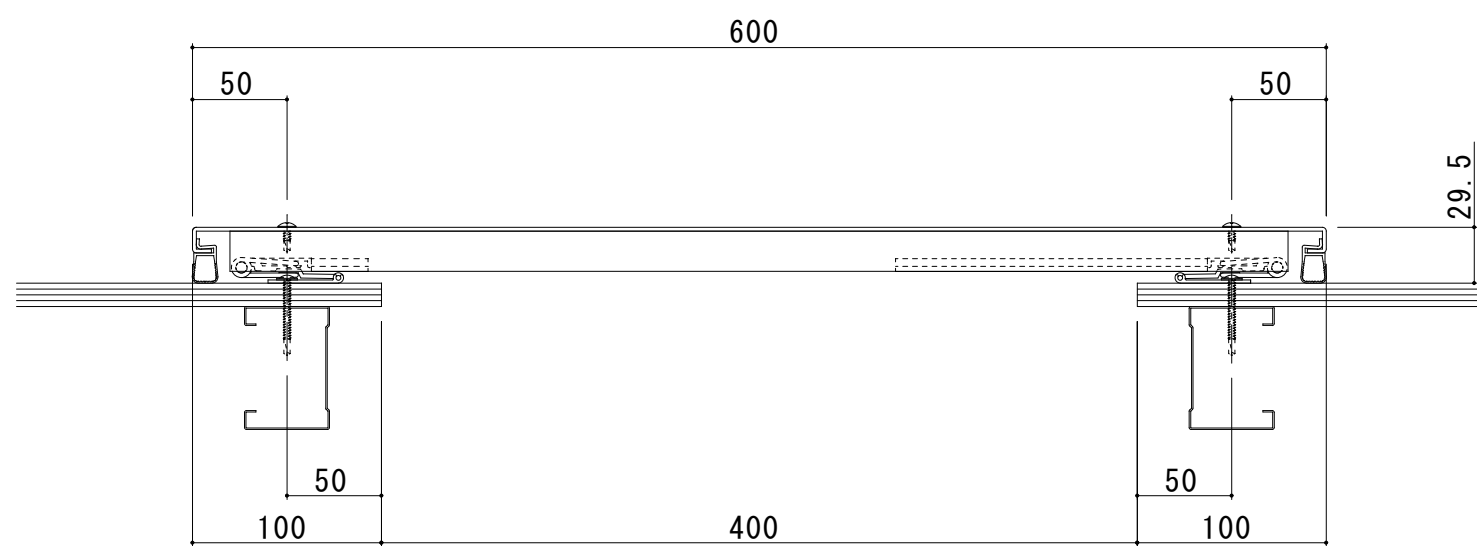

400-IE 断面图

屋根 - 外壁 (アルミ)

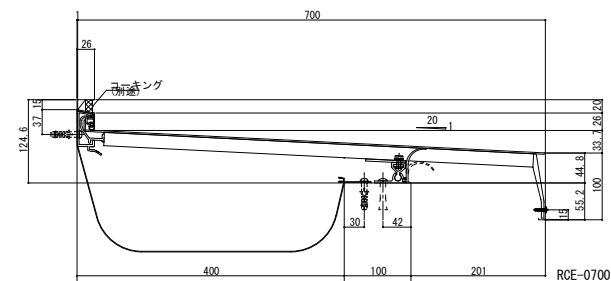
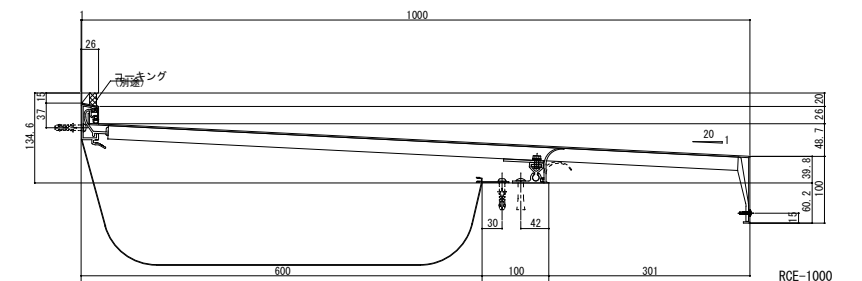
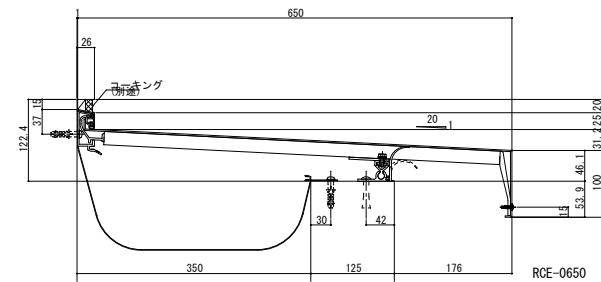
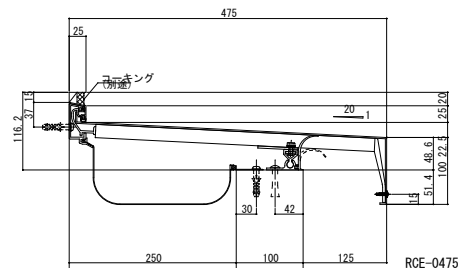
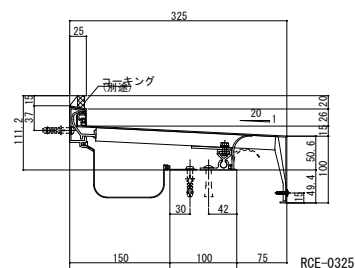
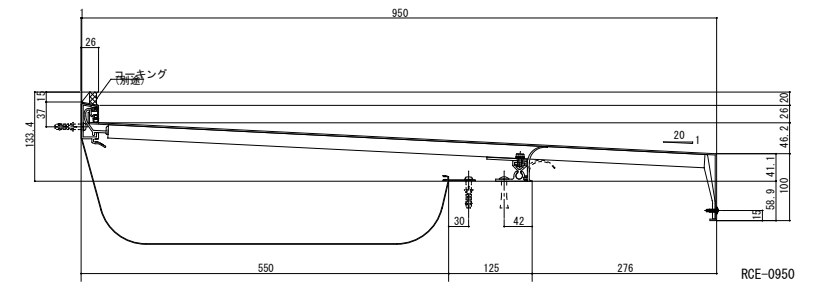
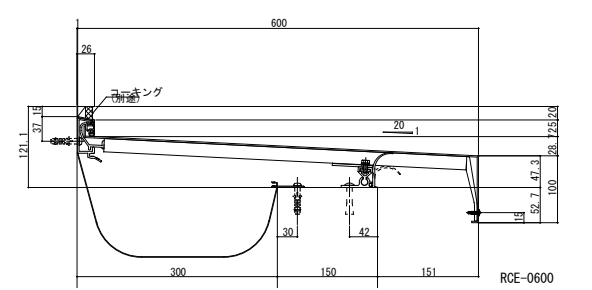
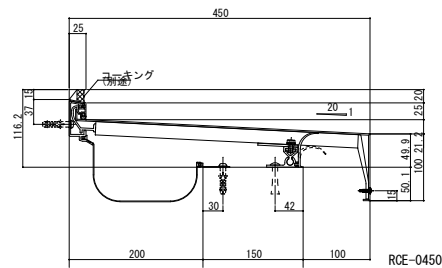
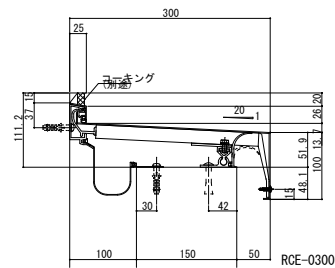
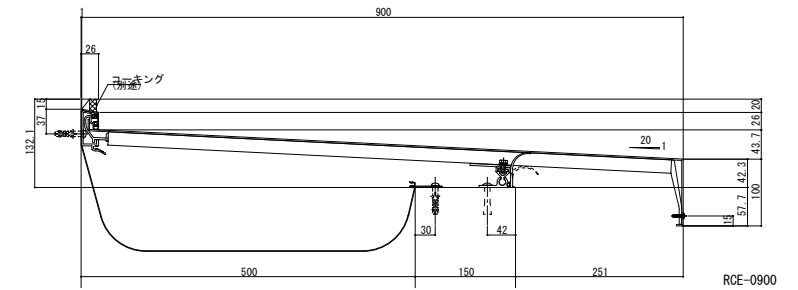
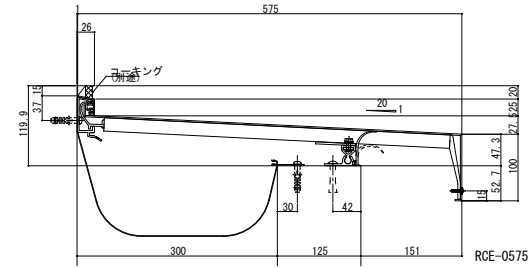
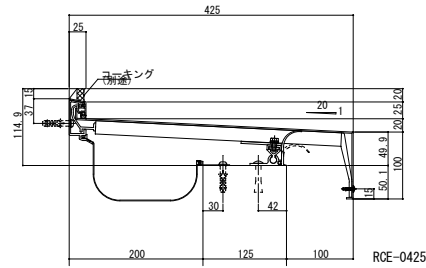
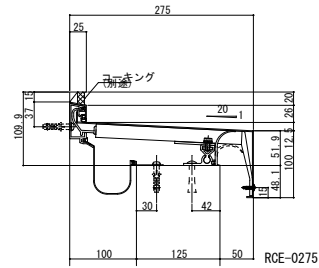
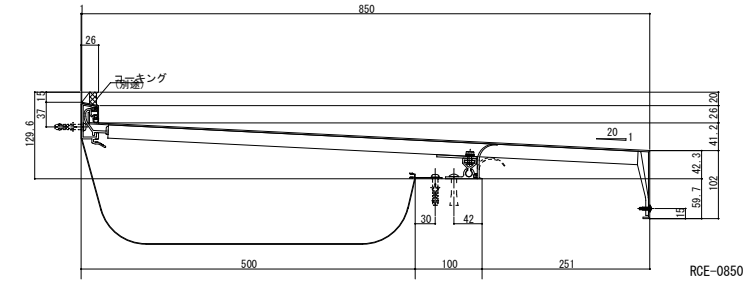
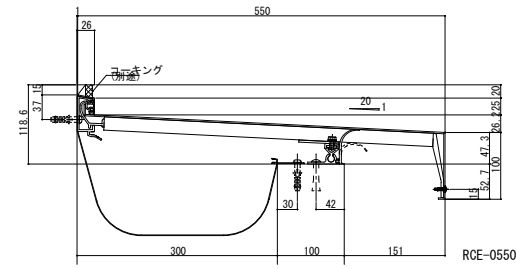
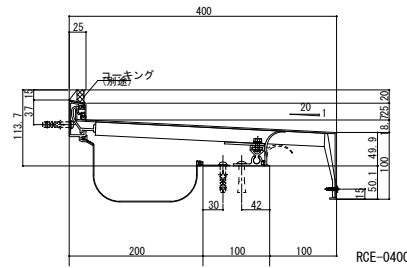
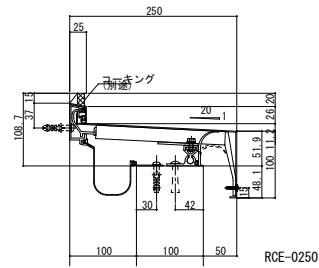
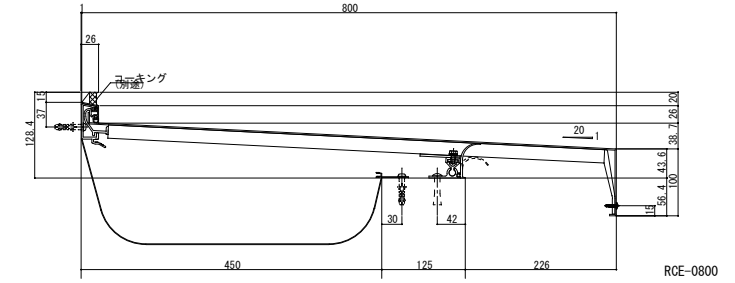
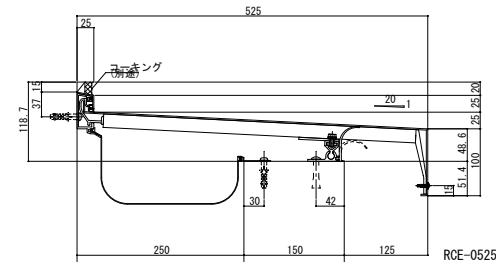
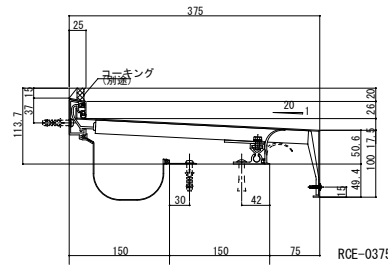
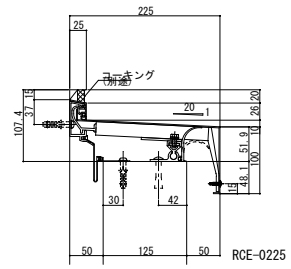
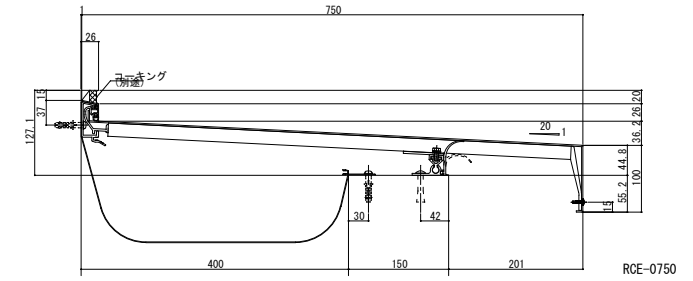
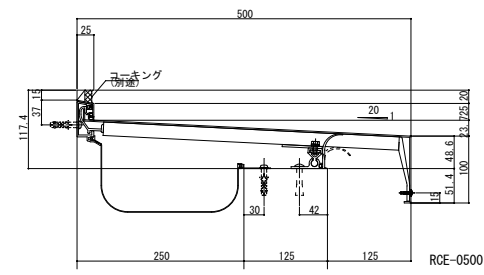
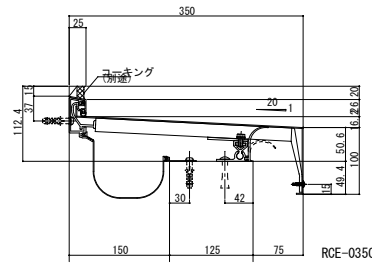
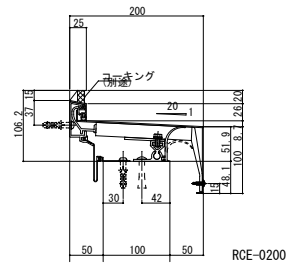
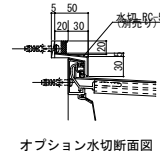
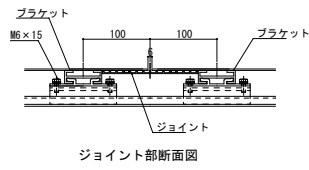

屋根－屋根（アルミ）

