

450-ECE 断面図

- ① ECEカバープレート (t=2.0)
- ② ECEブラケット (P=400)
- ③ 止水補助シートホルダー
- ④ ウェザーストリップ
- ⑤ 止水補助シート (別発注)
- ⑥ ドリルねじ (トラス頭4×13)
- ⑦ 木ねじ (5.5×40)
- ⑧ アンカーボルト (φ8)

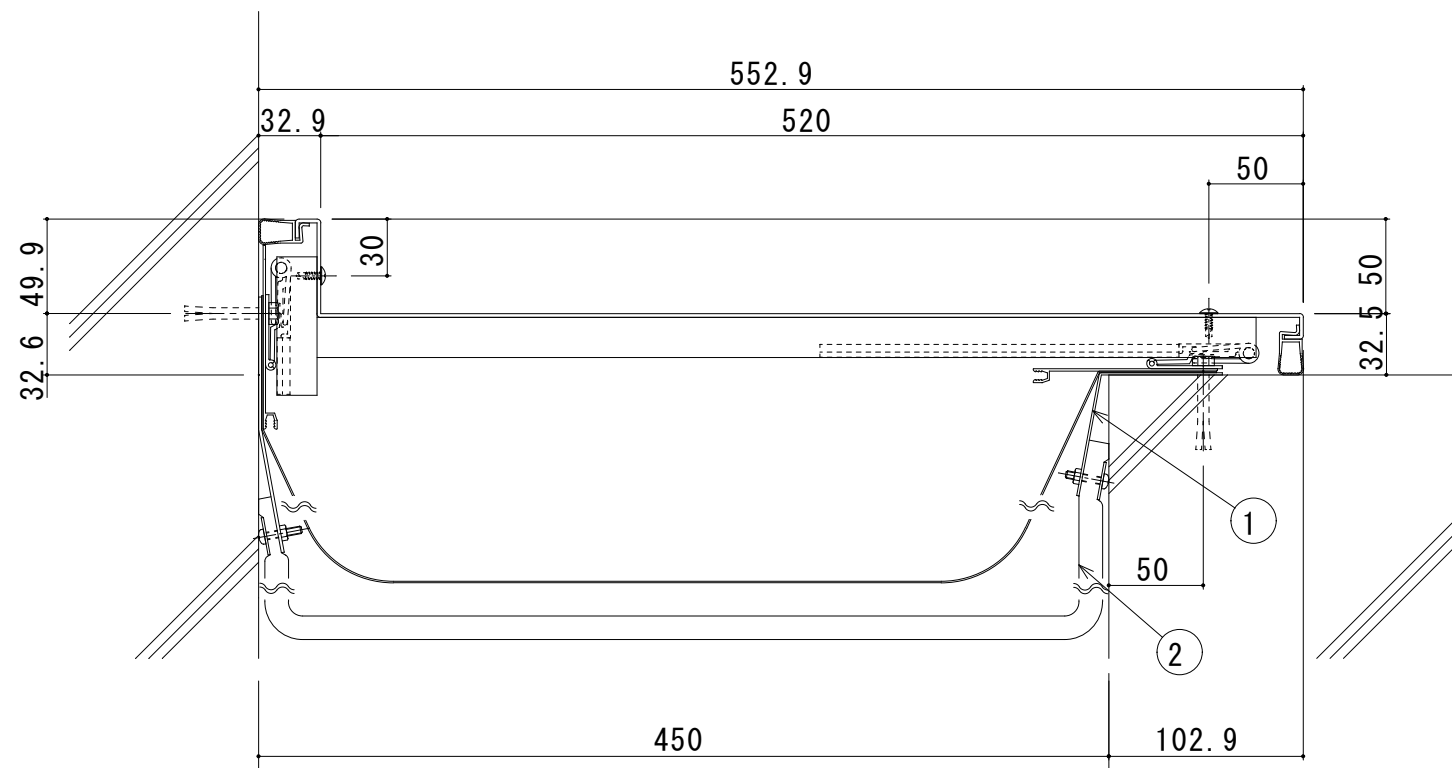

450-ECE (遮炎仕様) 断面図

- ① 耐火帯押えプレート
- ② 耐火帯

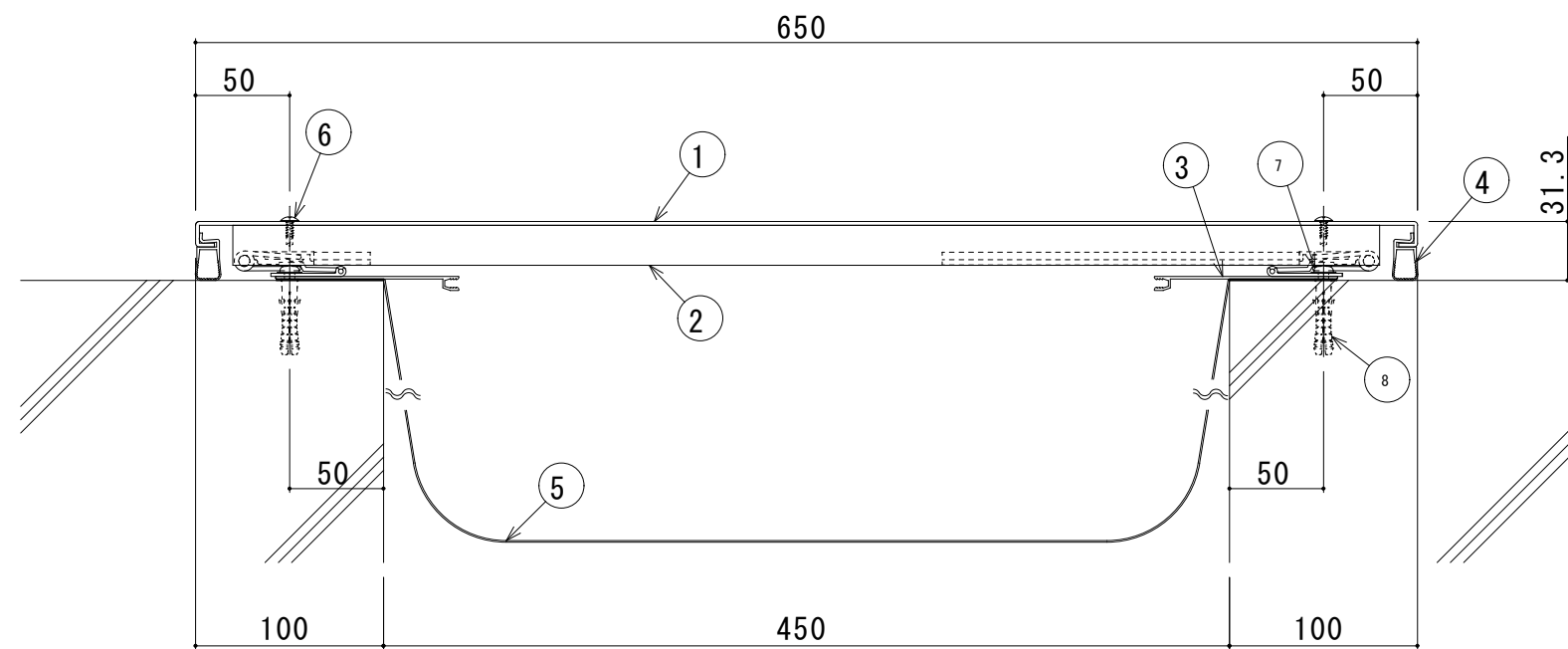

450-EE 断面図

- ① EEカバープレート (t=2.0)
- ② EEブラケット (P=400)
- ③ 止水補助シートホルダー
- ④ ウェザーストリップ
- ⑤ 止水補助シート (別発注)
- ⑥ ドリルねじ (トラス頭4×13)
- ⑦ 木ねじ (5.5×40)
- ⑧ アンカーフック (φ8)

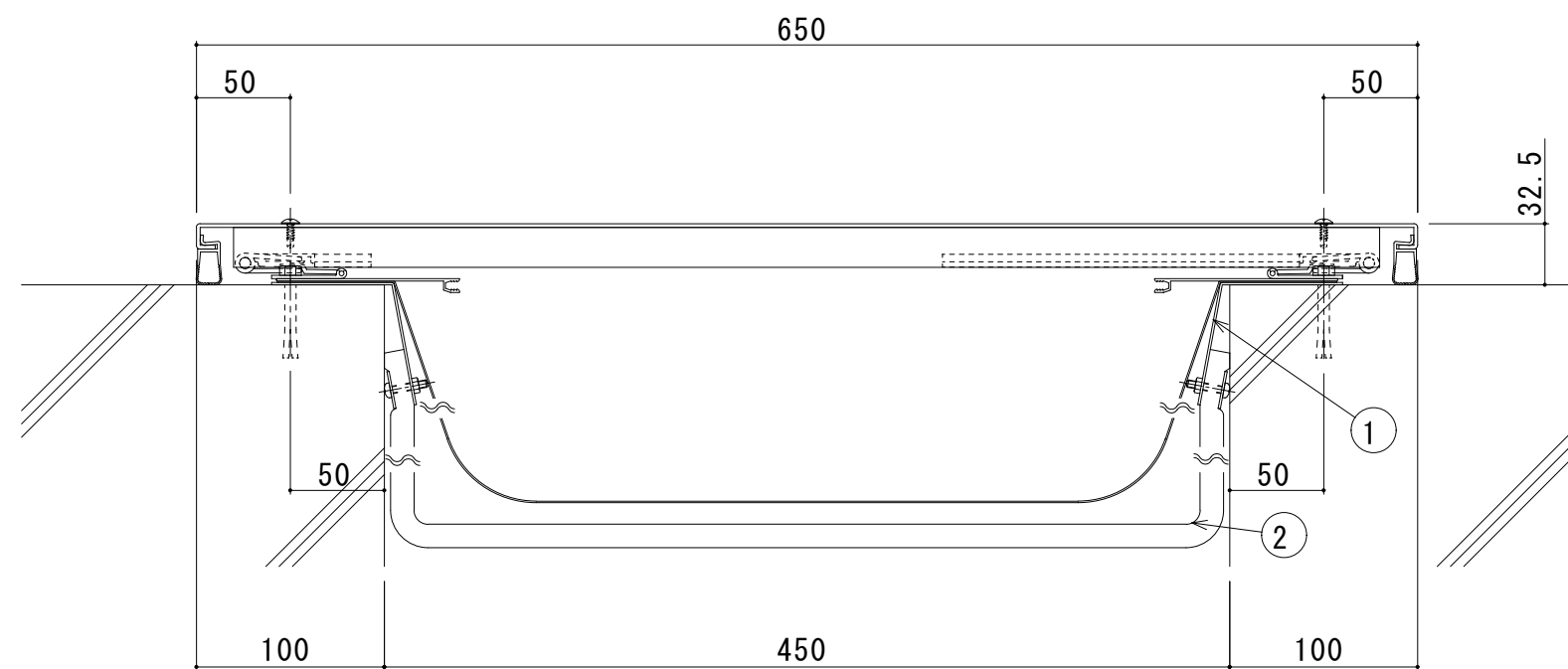

450-EE (遮炎仕様) 断面図

- ① 耐火帯押しプレート
- ② 耐火帯

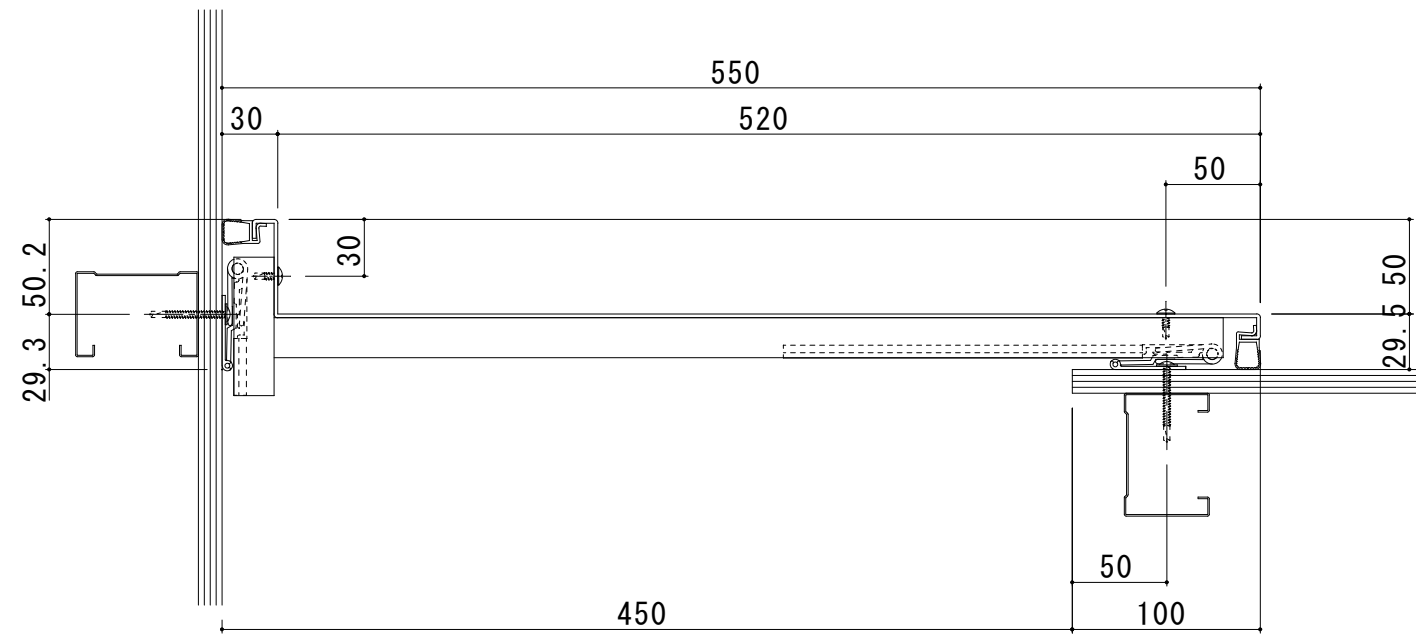

450-ICE 断面图

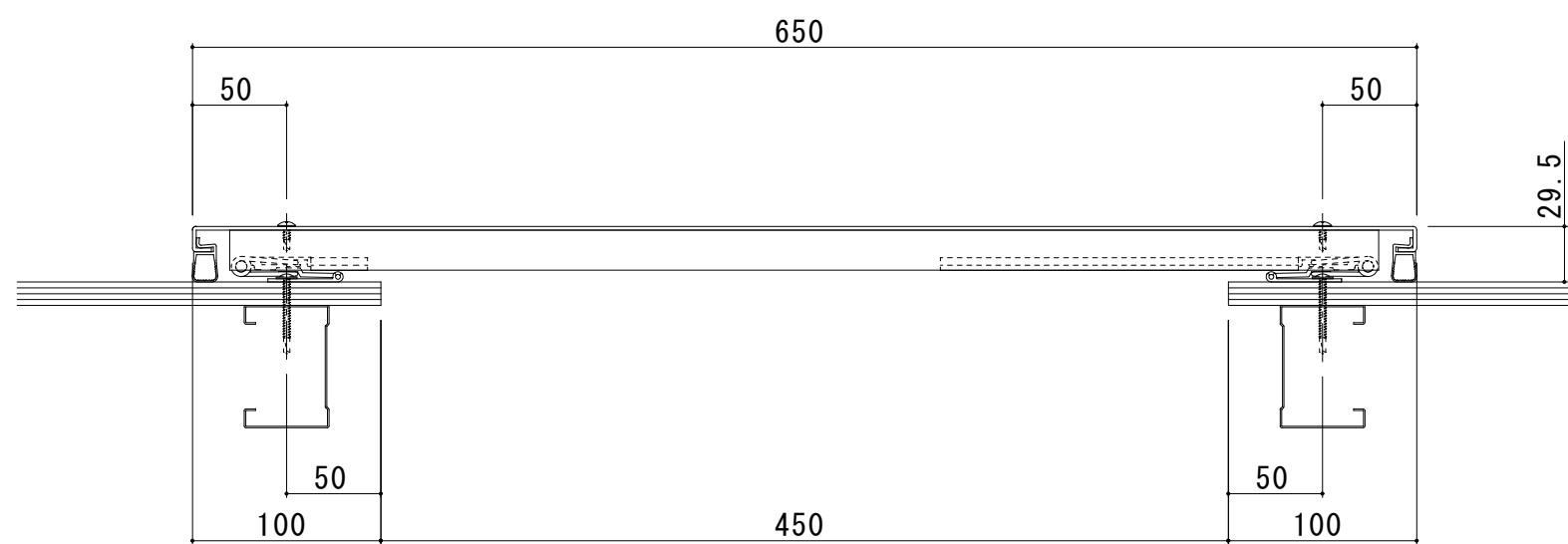

450-IE 断面图

【450mm用 耐火帯】

450-BE

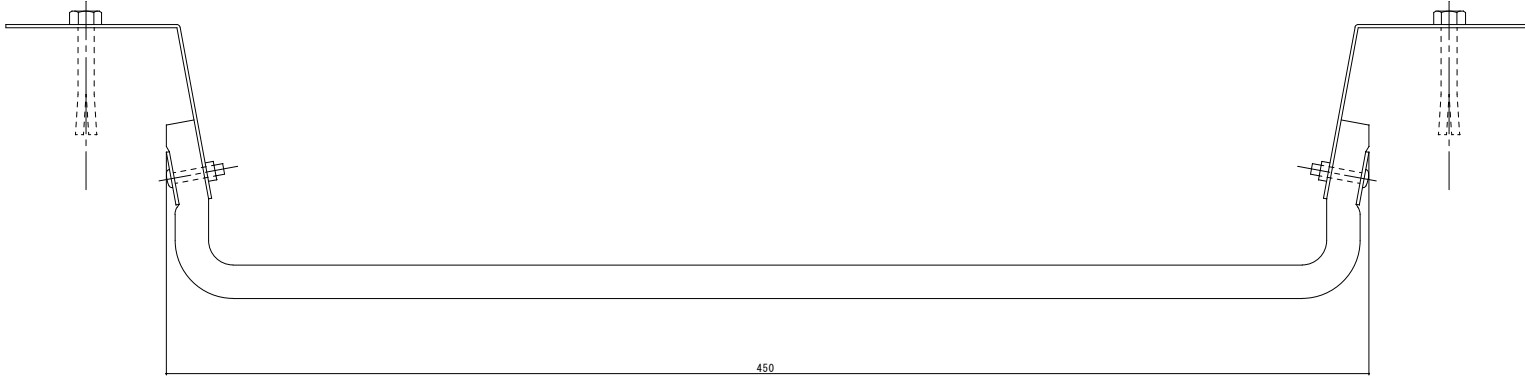

450-BCE

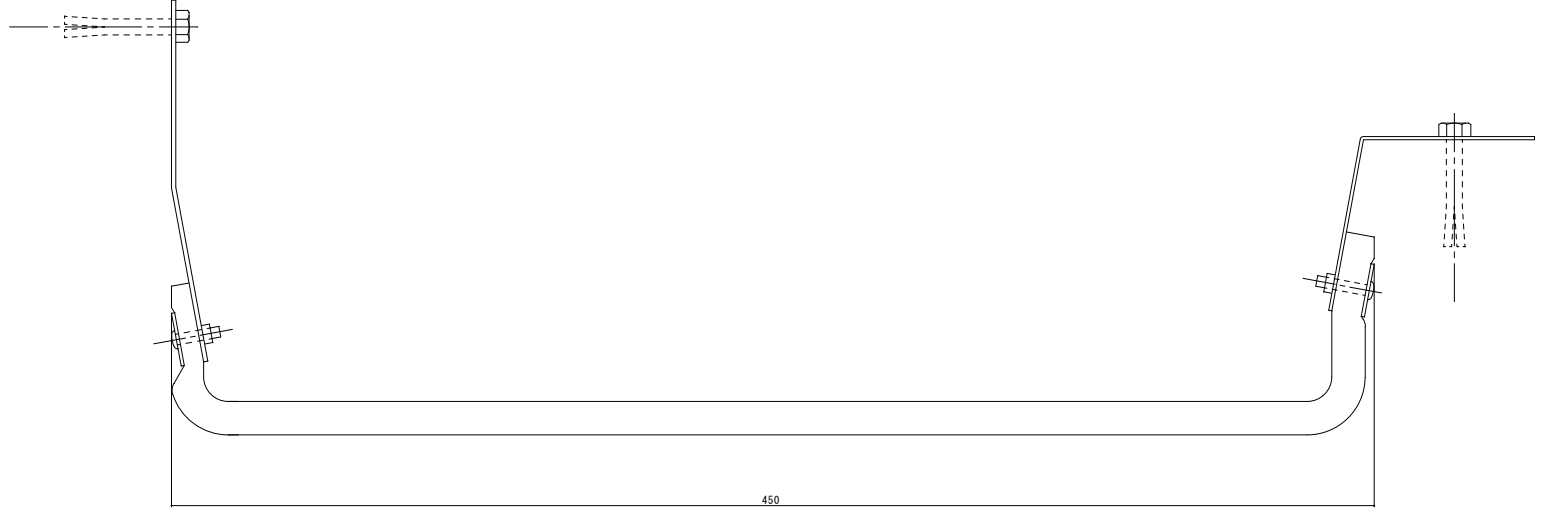

450-BN

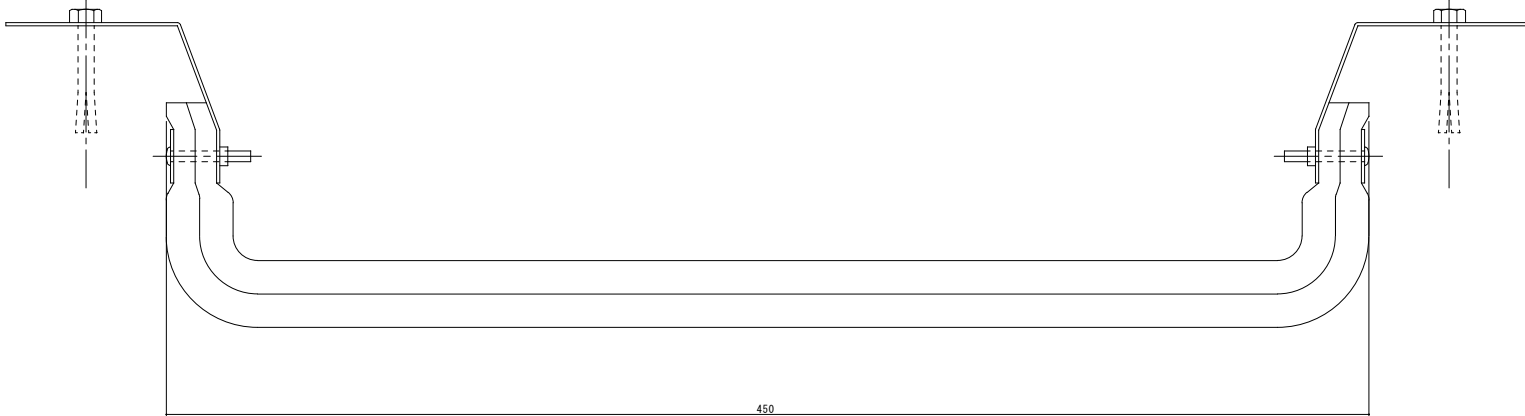

450-BCN

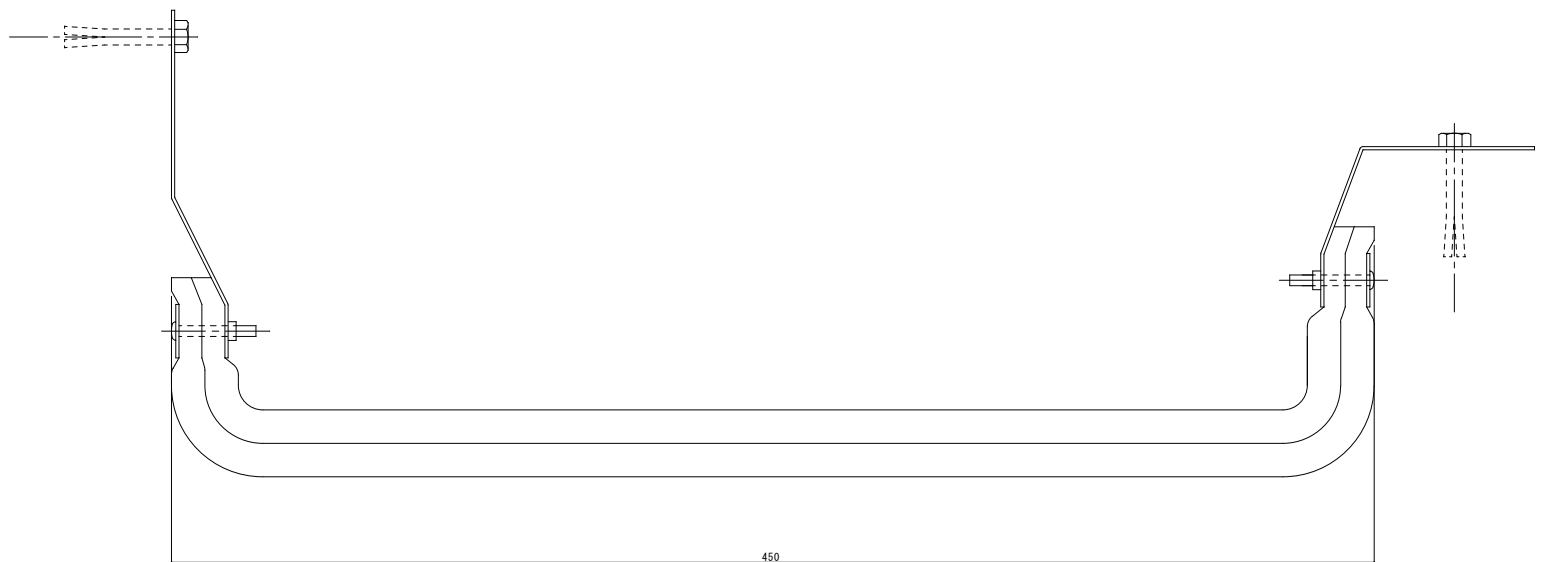

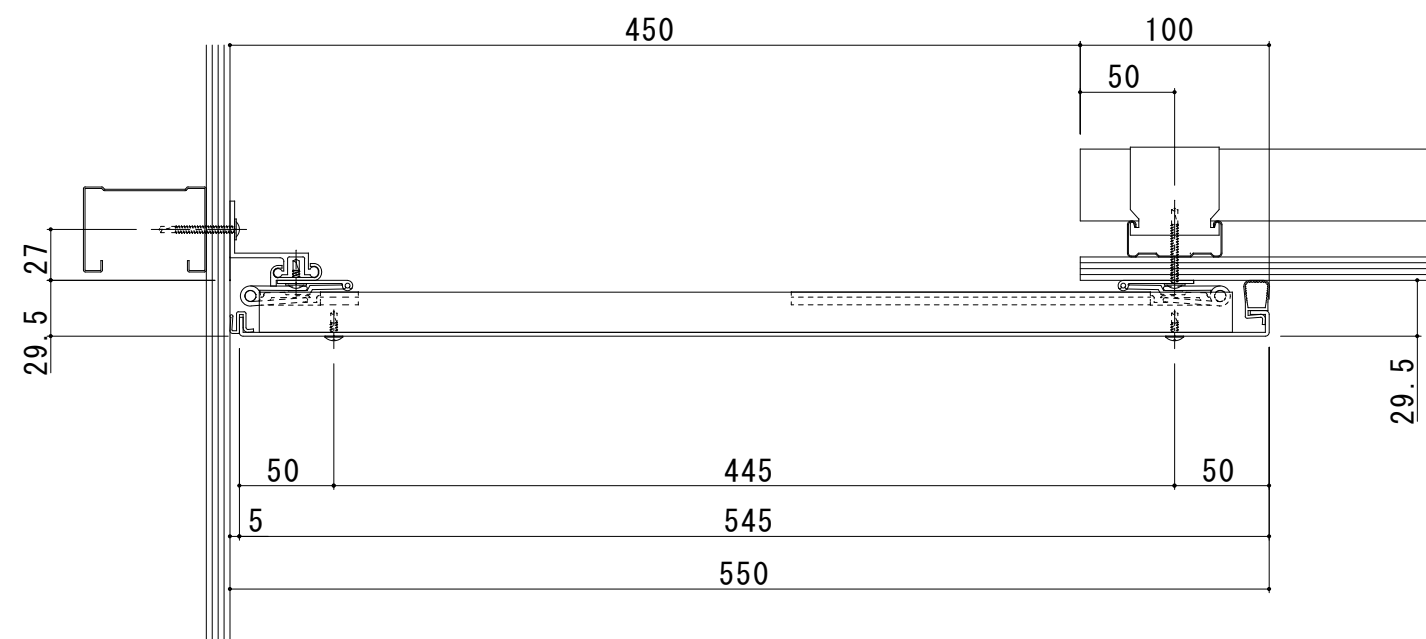

450-TCE 断面图

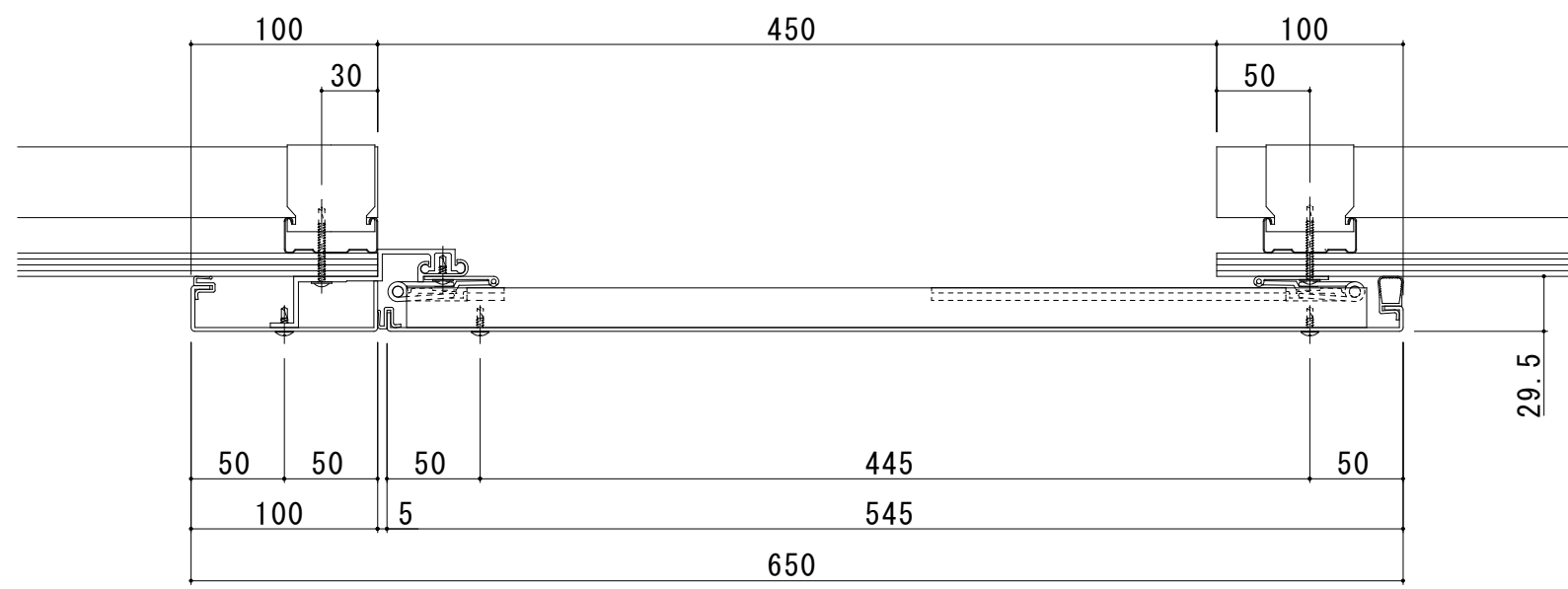

450-TE 断面图

屋根-外壁 (アルミ)

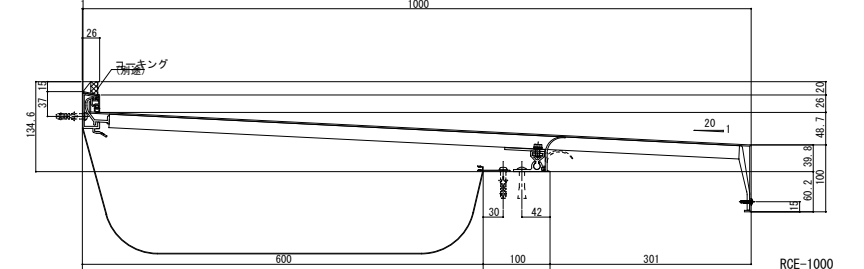
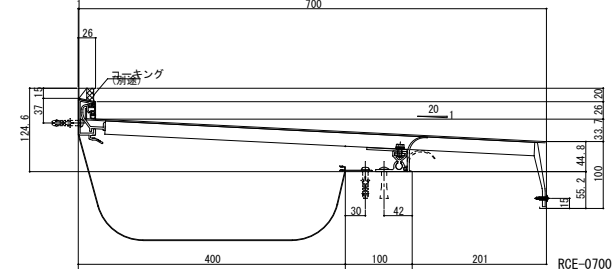
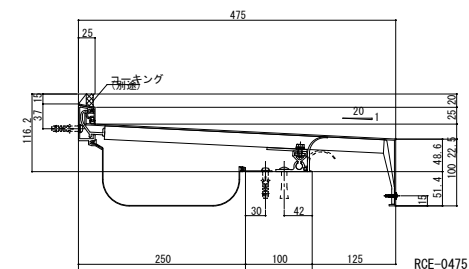
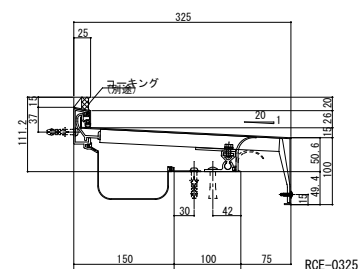
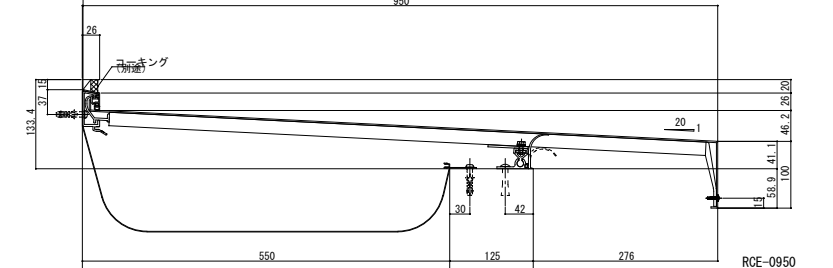
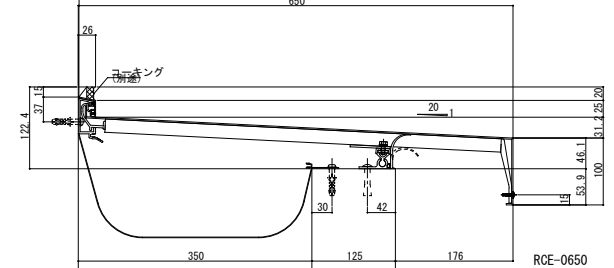
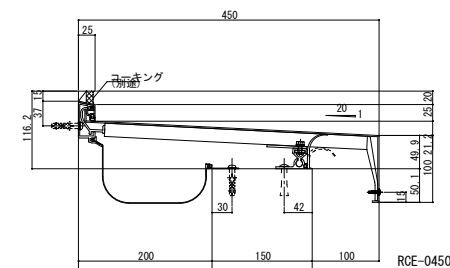
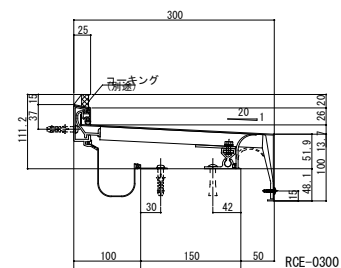
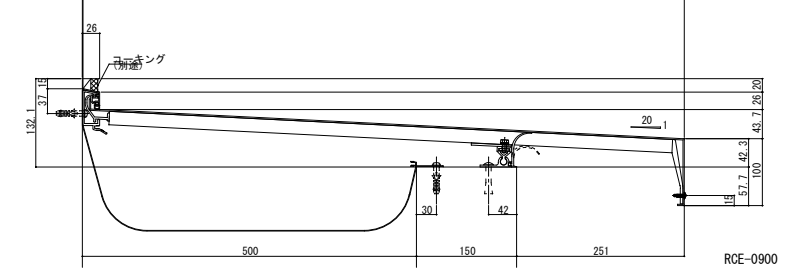
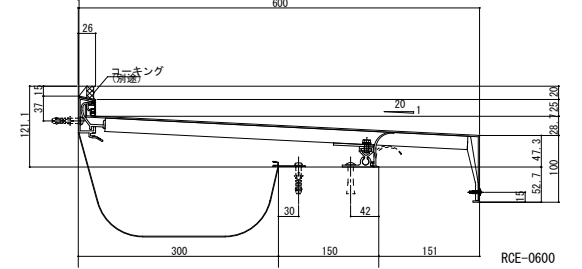
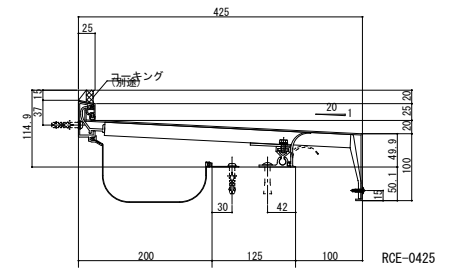
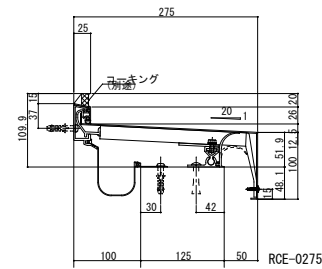
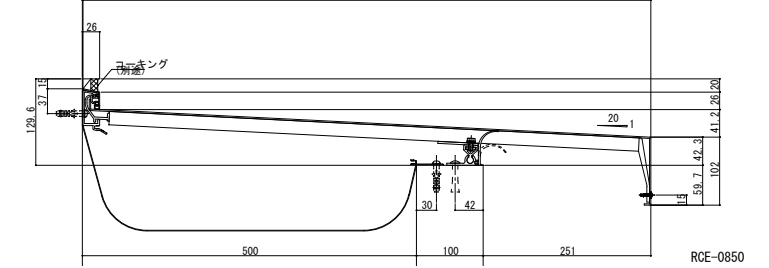
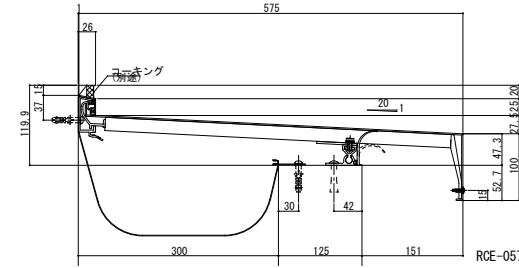
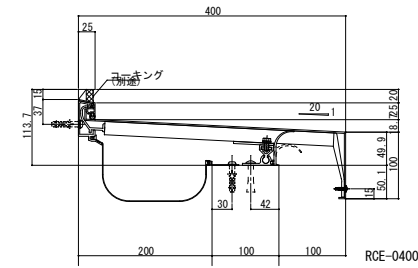
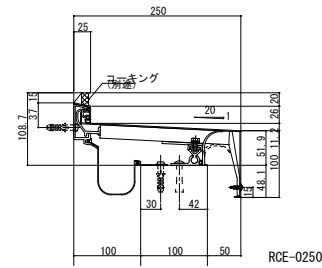
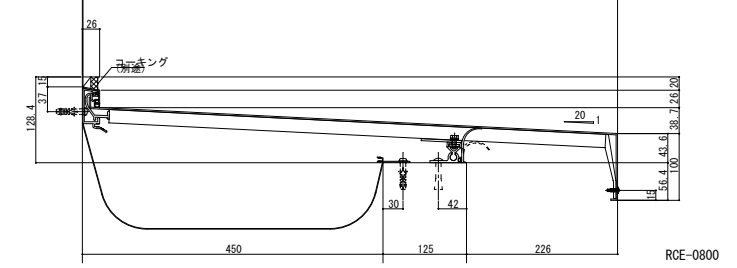
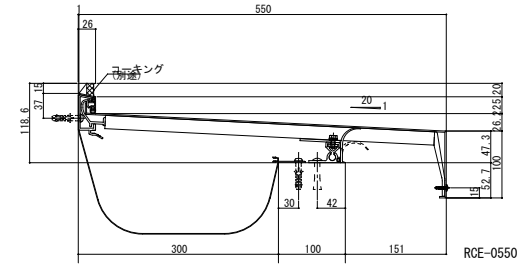
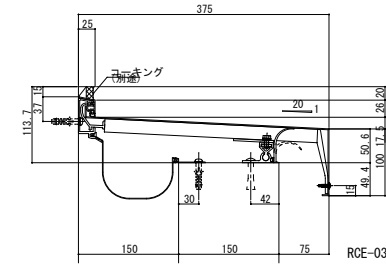
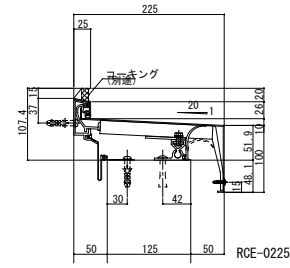
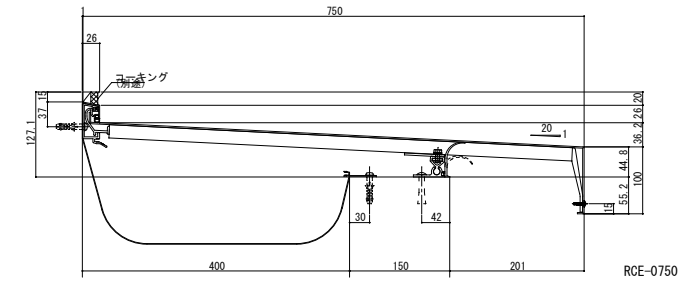
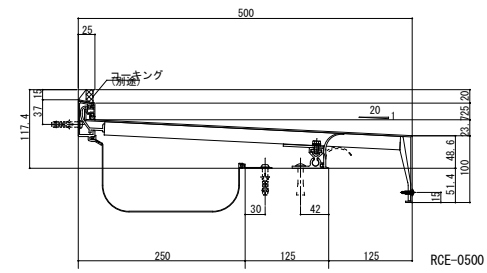
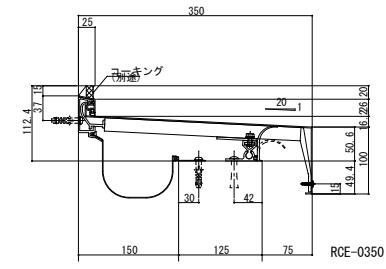
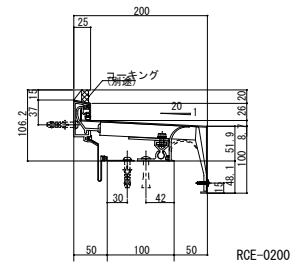
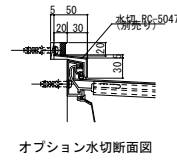
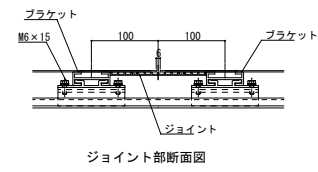

屋根－屋根（アルミ）

